

Type S/T mechanical dashboard drive



UNIQUE AUTOPILOT DRIVES FOR CABLE STEERED BOATS

PROFESSIONAL SOLUTION - Replaces manual helm with a manual helm/autopilot drive combination.



TYPE S BEHIND DASH DRIVE



TYPE T TILT BEHIND DASH DRIVE

totally out of sight!!!

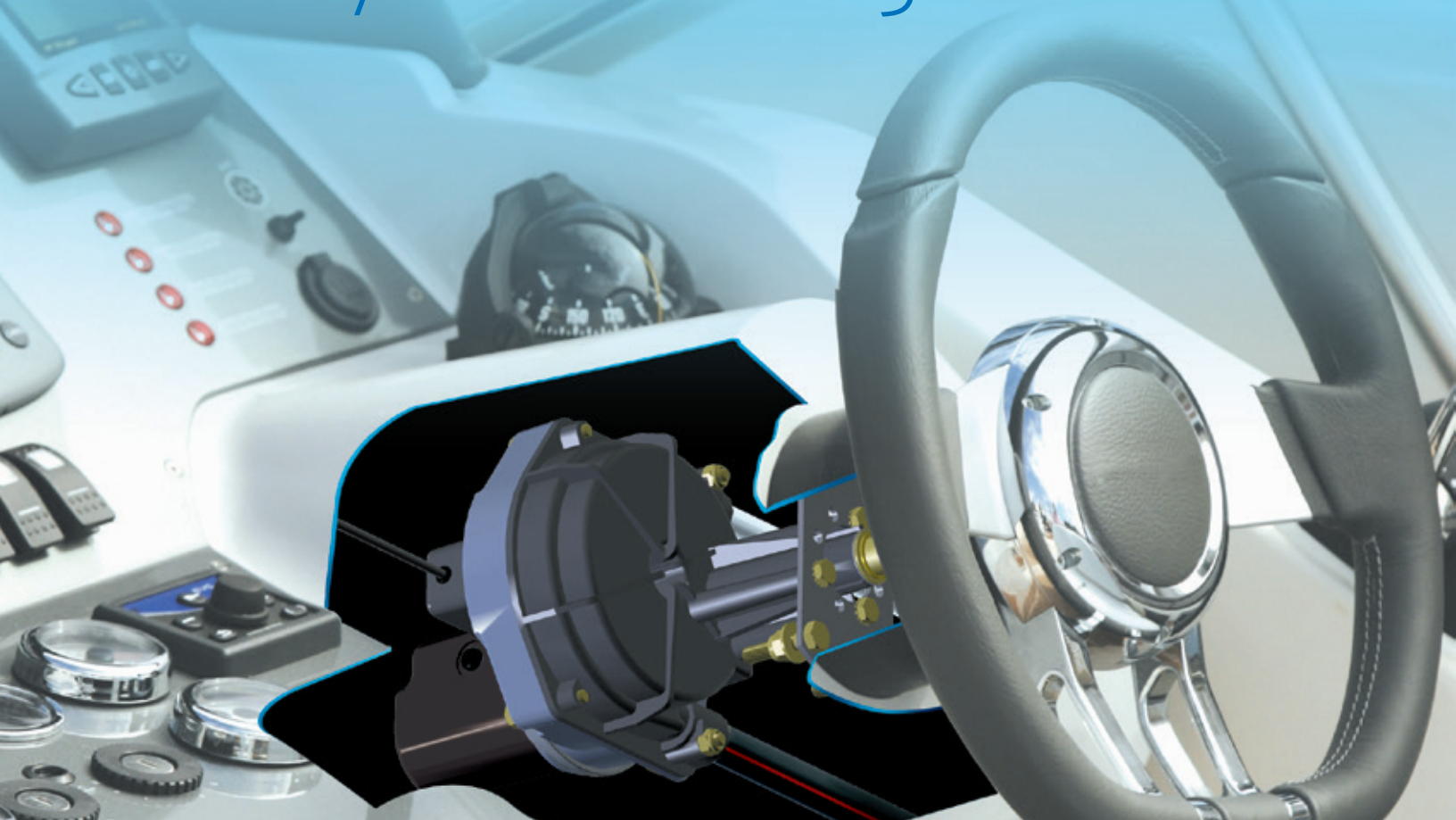

Type S/T mechanical dashboard drive specification



PROFESSIONAL SOLUTIONS FOR STERNDRIVE & OUTBOARD ENGINES

TYPE S BEHIND DASH DRIVE

The Straight shaft drive unit replaces the manual drive used on cable steered boats and is mounted directly behind the dash. The drive is directly compatible with the Morse 290 steering helm but comes with its own bezel kit and can be retrofitted in most installations using the cable and steering

wheel from the manual steering helm on the boat.



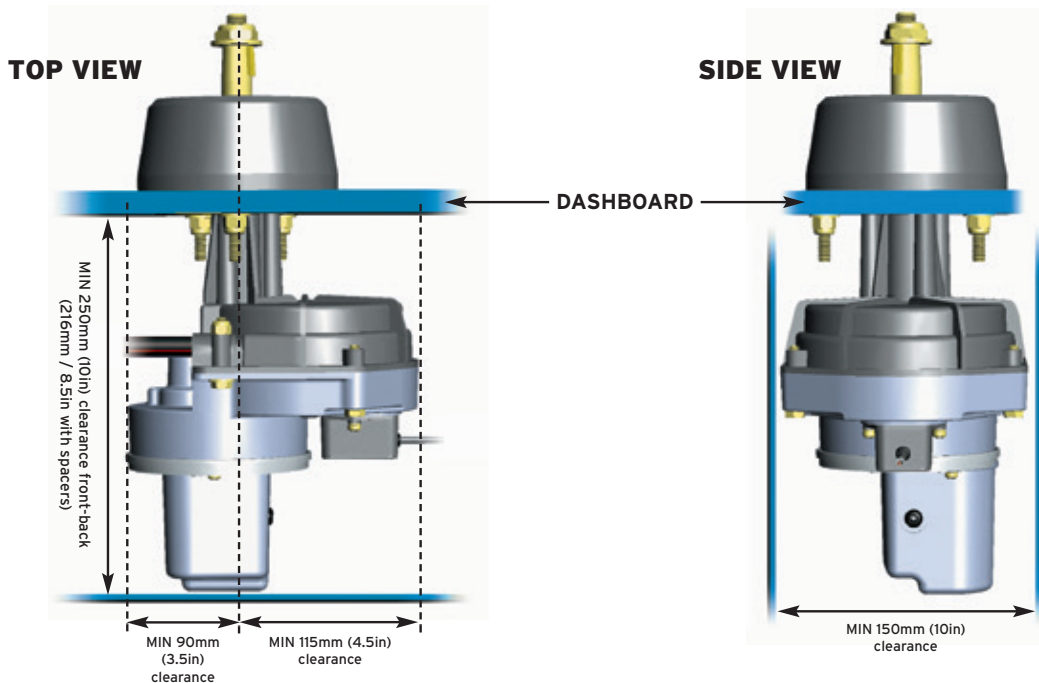

TYPE T TILT BEHIND DASH DRIVE

This drive unit replaces a manual Tilt drive and is mounted directly behind the dash, but still allows the angle of the steering wheel to be changed. It uses the front end from Teleflex SH91800 (not supplied).

SPACE REQUIRED - TYPE S & TYPE T



ACCESSORIES







-  **OC15SUK10** 90 degree Bezel Mounting Kit for Type S Straight Shaft Drive
-  **OC15SUK09** 20 degree Bezel Mounting Kit for Type S Straight Shaft Drive
-  **OC15SUK07** Steering Cable Adapter Kit for TFX SSC72, Uflex M47, Morse 304415
-  **OC15SUK08** Steering Cable Adapter Kit for TFX SSC62, Uflex M66
-  **OC15SUK11** Adjustable Friction Brake for Type S Straight Shaft Drive with 90° Bezel Kit
-  **OC15SUK16** Spacer Kit x 19mm for 90° Bezel Kit
-  **OC15SUK17** Spacer Kit x 16mm for 20° Bezel Kit
-  **OC15SUK18** Spacer Kit x 13mm for TFX Performance Tilt Mechanism (Type T)

OPTIONAL RUDDER FEEDBACK UNIT

One of the most complex and time-consuming aspects of autopilot installation is fitting the rudder feedback unit, ensuring that the geometry matches the full range of rudder movement. The Octopus rudder feedback unit solves these problems as it mounts directly to the drive unit itself.



RUDDER FEEDBACK MODULES

-  **OC15SUK27** Universal Model for all autopilots
-  **OC15SUK27A** For Comnav & Sitex Autopilots
-  **OC15SUK27B** For Raymarine Autopilots
-  **OC15SUK27D** For Coursemaster & Simrad Autopilots
-  **OC15SUK27E** For Garmin, Furuno, Navman & TMQ Autopilots
-  **OC15SUK83** Simrad Resistance to Frequency Conversion Kit - Required for Simrad Autopilots